

Shop » filtri antidisturbo emi » filtri trifase



FILTRO 55A 600V AC, TRIFASE SCATOLATO EMI

55A (UL-ENEC)
Tensione 600/347V AC – 50/60Hz
Categoria Climatica: HPF 25/100/21
Massima corrente di fuga:
@480VAC 50/60Hz: 33mA
Hi-pot L-L: 2100VDC
Hi-pot L-PE: 2650VDC

COD: **55S5-1AH1-T(58)**

MARCA: **HIGH&LOW CORP.**



DISEGNO

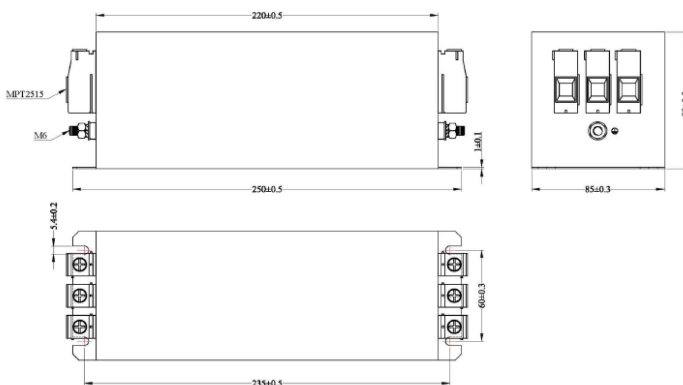

SPECIFICHE

Tensione	600/347V AC
Montaggio	morsettiera
Modello	3ph
Corrente Nominale	55A
N° di Stadi	1

CIRCUITO

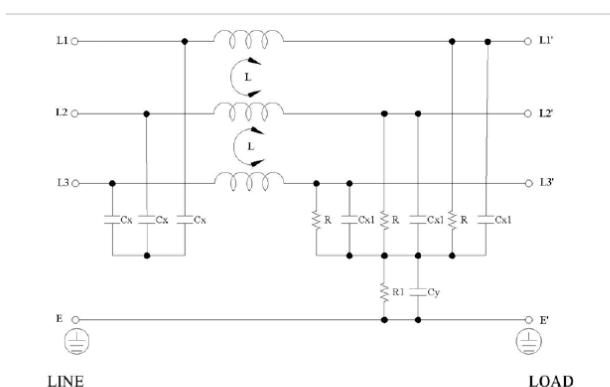

CURVA DI ATTENUAZIONE

